



OWNERS MANUAL & INSTALLATION INSTRUCTIONS

Model DDPV50 & DDPV54

CAUTION: THIS UNIT HAS ROTATING PARTS AND SAFETY PRECAUTIONS SHOULD BE EXERCISED DURING INSTALLATION, OPERATION AND MAINTENANCE.

DO NOT USE FAN(S) IN HAZARDOUS ENVIRONMENTS WHERE THE FANS ELECTRICAL SYSTEM COULD PROVIDE IGNITION OF COMBUSTABLE OR FLAMMABLE MATERIALS UNLESS BUILT SPECIFICALLY FOR THAT ENVIRONMENT.

SAFETY GUARDS ARE REQUIRED WHEN THE FAN IS WITHIN SEVEN(7) FEET OF THE FLOOR, WORKING LEVEL OR WITHIN REACH OF PERSONNEL.

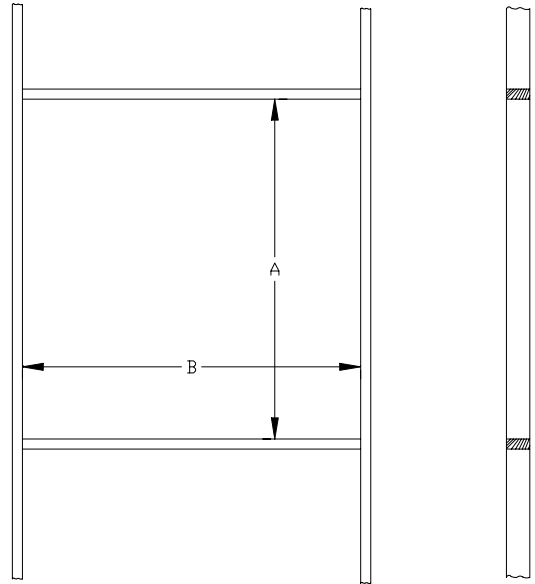

FIGURE 1

For fans installed side-by-side, allow a minimum of one diffuser diameter between fans. A distance of at least one and one half times the diameter of the fan should be allowed between the fan discharge opening and any adjacent wall or large obstruction.

Fan Size	Rough Opening				Diffuser Discharge Diameter	
	A		B		IN	mm
	IN	mm	IN	mm		
50	53	1346	53	1346	66.06	1678
54	56.5	1435	56.5	1435	69.9	1775

INSTALLATION INSTRUCTIONS

1. Provide an opening in the wall for the fan housing with inside framing dimensions as shown in Figure 1 and Table 1. It is preferable to frame the opening with 2" wood material (2" x 6" or 2" x 8") or a metal frame.
2. Remove shipping crating. If the diffuser is in the fan crate, remove diffuser parts, discharge guard and hardware bag from the fan housing.
3. The housing is designed for installation to the inside of the framed opening. Caulk under the housing flange as needed. Starting with the TOP two support brackets (two on top and two on bottom) secure to the framing using the 1/4" x 1 1/2" screws provided, through the slots into the framing as shown in Figure 2.
4. Use the 1/4" x 1 1/2" screws and washers provided, secure the housing flange to the inside of the framed opening.

WARNING: Failure to attach brackets to the top and bottom of the framing will result in damage to the fan and loss of Acme warranty.

5. Shutter Installation

Prior to shutter installation, the following tasks should be completed:
Check all fasteners for tightness. For belt driven units, belt tightness should be such that belt should depress its width when pressed firmly midway between the pulleys. Turn the propeller by hand to make sure it is in alignment with the orifice and fan blades are centered in the orifice.

TABLE 1

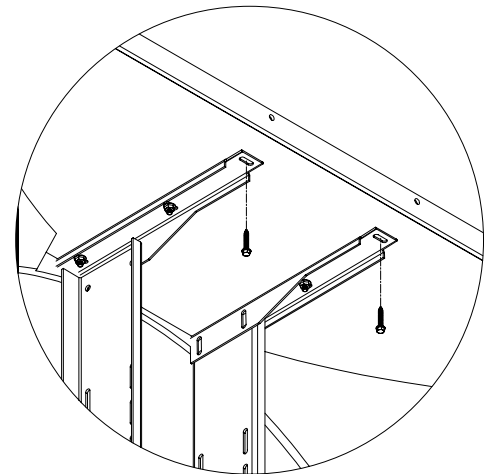

FIGURE 2

Metal Shutter - Install shutter clips in the pre-drilled pilot holes with the #10 x 1" screws provided. See Figure 3. The screws should be tightened until they are snug, but should not be tightened to the point that the shutter clip will not turn. There will be 8 clips for the size 50 and 54.

Plastic Shutter - Drop the shutter into the wall box and slide it all the way down to the bottom of the box. Mount the shutter clip locations 1" from the shutter flange in the predrilled holes. Install 4 clips on the top and bottom of the shutter. Install 2 shutter clips equally spaced on the sides of the fan.

Note: The side clips are packaged with the plastic shutter.

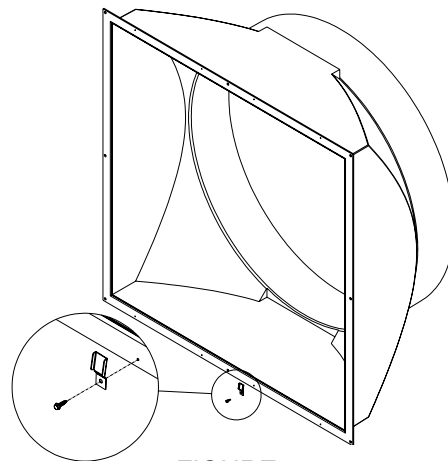

FIGURE 3

6. Diffuser Installation

Note: The diffuser can be a one piece design or four piece design. If it is a multiple piece design, assemble the diffuser and follow the instructions below.

Slide the diffuser around the outside of the orifice until the orifice touches the radius of the diffuser. See Figure 4. Drill (6) 9/32" holes into diffuser flange (one in the center of each notched section on the diffuser flange). Start these holes from the orifice side (from the inside, drill the fiberglass orifice first and the diffuser second). The (6) holes should be approximately 1/2" from the edge of the orifice on the fan, see Figure 4. Secure the diffuser flange to the orifice with 1/4" bolts (insert bolts from the inside of the orifice), lock nuts and washers provided.

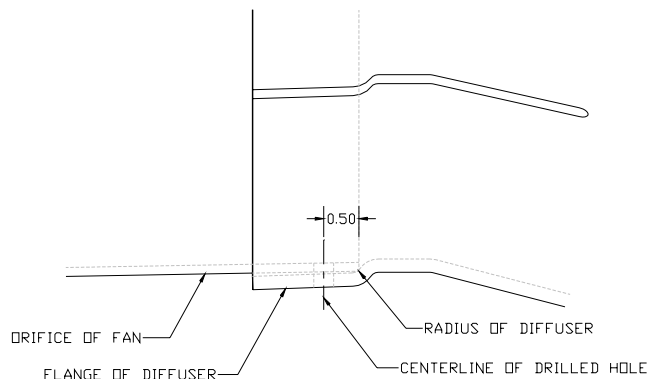

FIGURE 4

7. Discharge Guard Installation

Place the guard inside the diffuser (eyelets of guard pointing away from the propeller) and line guard eyelets up with the diffuser. Attach the guard to the diffuser using the 1/4" x 3/4" WHIZ lock bolts and nuts provided.

NOTE: SAFETY GUARDS MUST BE IN PLACE DURING OPERATION.

CAUTION: Before proceeding, make sure the electrical service to the fan is in the "OFF" position.

8. Inlet Guard Installation

If ordered, inlet guards are to be secured over the shutter with the clips provided in Step #4.

9. Check the voltage being supplied to the fan to see that it corresponds with the motor nameplate voltage.

WARNING: HIGH OR LOW VOLTAGE CAN SERIOUSLY DAMAGE THE MOTOR.

Make wiring connections to the motor through the "knockout" in the top shutter flange. All wiring should be in accordance with local ordinances and the National Electric Code.

10. Momentarily operate the fan under power and compare propeller rotation with directional arrow on fan. Motor reversing instructions will be found on the motor wiring diagram if motor needs reversing.

11. Safety Guards must be in place during operation. Fan inlet guard is optional.

PARTS DESCRIPTION

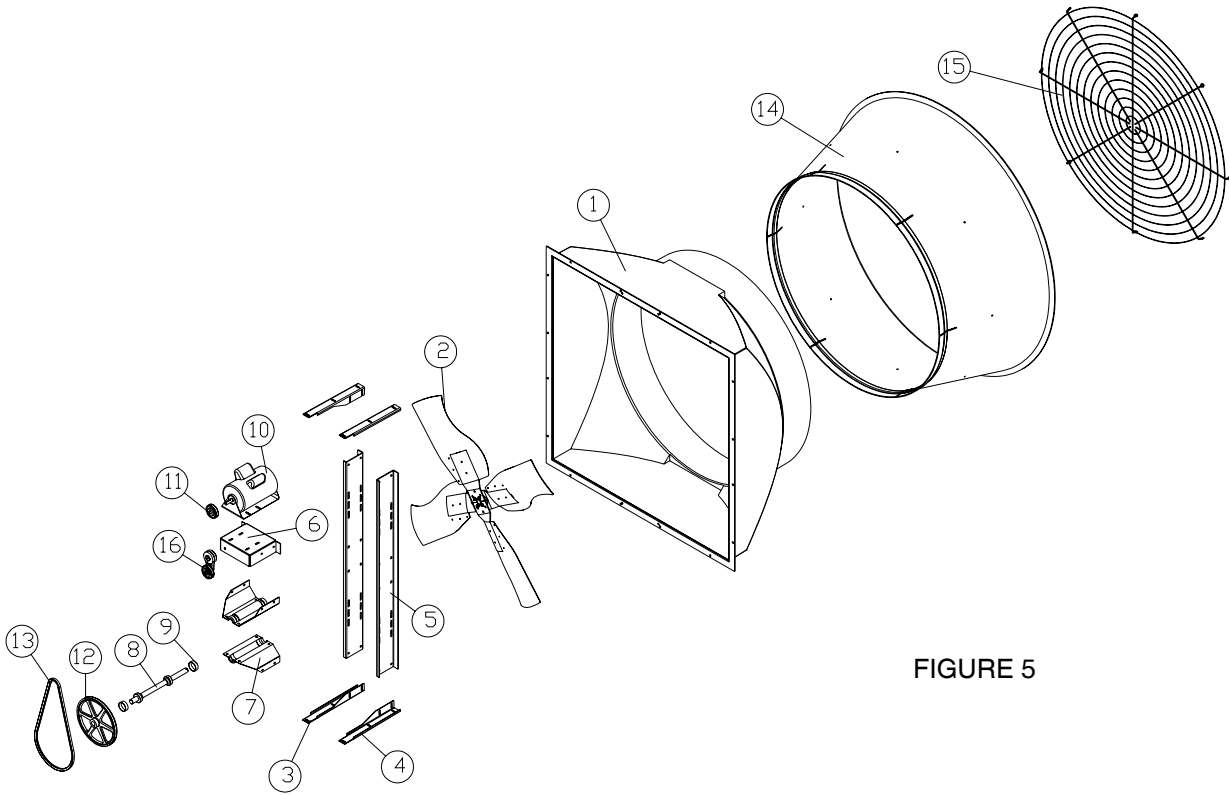

FIGURE 5

No.	Qty.	Description	No.	Qty.	Description
1	1	Inlet & Wall Box	9	2	Rubber Ring
2	1	Propeller Assembly	10	1	Motor
3	2	Support Mounting Bracket Left	11	1	Motor Sheave
4	2	Support Mounting Bracket Right	12	1	Fan Sheave
5	2	Support Channel	13	1	Belt
6	1	Motor Base	14	1	Diffuser
7	2	Bearing Base	15	1	Discharge Guard
8	1	Shaft & Bearing Assembly	16	1	Belt Tightener - Optional

TABLE 2

TERMS AND CONDITIONS OF SALE

ACCEPTANCE All orders and sales are subject to written approval and acceptance by an executive officer of Acme Engineering & Manufacturing Corporation at Muskogee, Oklahoma, (the "Company") and are not binding on the Company until so approved.

DELIVERY All shipping and delivery dates are estimated only. No delays in delivery will subject the Company to any costs, damages or fees for late delivery. Delivery of the products herein specified shall be made F.O.B. point of shipment, unless otherwise stated. The Company shall not be liable for delay due to causes beyond its reasonable control, such as Acts of God, acts of the purchaser, acts of civil or military authorities, priorities, fires, strikes, floods, epidemics, war, riots, delays in transportation, car shortages, and inability, due to reasons beyond its reasonable control, to obtain necessary labor, material, or manufacturing facilities. In the event of such a delay, the date of delivery shall be extended for a period equal to the time lost by reason of the delay.

TERMS OF PAYMENT If, in the judgment of the Company, the financial condition of the purchaser at any time does not justify continuation of manufacture or shipment on the terms of payment specified, the Company may require full or partial payment in advance.

Pro rata payments shall become due as shipments are made. Each shipment or delivery shall constitute a separate sale, and the default of any shipment or delivery shall constitute a separate sale, and the default of any shipment or delivery shall not vitiate the contract as to other shipments or deliveries.

SALES AND SIMILAR TAXES The Company's prices do not include sales, use, excise, or similar taxes. Consequently, in addition to the price specified herein, the amount of any present or future sales, use, excise, or other similar tax applicable to the sale of the product herein shall be paid by the Purchaser, or in lieu thereof

the Purchaser shall provide the Company with a tax exemption certificate acceptable to the taxing authorities.

CANCELLATION Any contract resulting from the Purchaser's order may be canceled by the Purchaser only by negotiations and upon payments of reasonable cancellation charges which will take into account expenses already incurred and commitments made by the Company.

DESIGN CHANGES The Company reserves the right to make changes in design, improvements and additions in and to its products any time without imposing any liability or obligations to itself to apply or install the same in any product manufactured by it.

TITLE The title and right of possession of the products sold herein shall remain with the Company and such products shall remain personal property until all payments herein (including deferred payments whether evidenced by notes or otherwise) shall have been made in full in cash and the Purchaser agrees to do all acts necessary to perfect and maintain such right and title in the Company.

PRICE ADJUSTMENTS Prices are subject to change upon notice by the Company. Prices on existing orders are subject to surcharges in the event of cost increases of metals and transportation. All complete component accessory material manufactured by others and furnished with the Company's products such as motors, drives, vibration equipment, controls or other completely assembled component structures, are subject to adjustment to the price at time of shipment regardless of the date of original order entry.

SAFETY ACCESSORIES The Company manufactures products designed to serve multiple applications and offers a wide range of safety equipment, including guards and other devices, as may be required to meet

customer specifications. Without exception, the Company recommends that all orders include applicable safety devices. Products ordered without applicable safety devices is clearly the responsibility of the Purchaser. Further, the Purchaser warrants that it has determined and acquired any and all safety devices required for products sold by the Company. Weather covers and guards for motor and V-belt drives, couplings, shafts and bearings, along with inlet and outlet screens, are optional accessories noted in the price list.

GOVERNING LAW The rights, obligations and remedies of Purchaser and the Company, the interpretation of these terms and conditions and the sale of products by the Company shall be governed by Oklahoma law, without regard to any principles of conflict of laws.

ARBITRATION Any dispute arising under or in connection with these terms and conditions or the sale of products shall be settled by binding arbitration administered by the American Arbitration Association under its Commercial Arbitration Rules, and judgment on the award rendered by the arbitrator may be entered in any court having jurisdiction thereof. The dispute shall be resolved by one neutral arbitrator who shall have no affiliation with either Purchaser or the Company and shall be selected by the American Arbitration Association office in Dallas, Texas. The arbitration proceedings shall be held in Muskogee, Oklahoma.

APPLICABLE DOCUMENTS The agreement between the Company and the Purchaser relating to the products includes these terms and conditions of sale, any applicable installation and maintenance instructions provided by the Company and any terms appearing on the Company's quotation, sales order acknowledgment and invoice.

WARNING Acme products are designed and manufactured to provide reliable performance but they are not guaranteed to be 100% free of defects. Even reliable products will experience occasional failures and this possibility should be recognized by the Purchaser and all End Users. If these products are used in a life support ventilation system where failure could result in loss or injury, the Purchaser and all End Users should provide adequate back-up ventilation, supplementary natural ventilation or failure alarm system, or acknowledge willingness to accept the risk of such loss or injury.

WARNING DO NOT use in HAZARDOUS ENVIRONMENTS where fan's electrical system could provide ignition to combustible or flammable materials unless unit is specifically built for hazardous environments. Comply with all local and national safety codes including the National Electrical Code (NEC) and National Fire Protection Act (NFPA).

CAUTION Guards must be installed when fan is within reach of personnel or within eight (8) feet (2.5 m) of working level or when deemed advisable for safety.

DISCLAIMER The Company has made a diligent effort to illustrate and describe the products accurately in all Company literature; however such illustrations and descriptions are for the sole purpose of identification and do not express or imply any warranty.

LIMITED WARRANTY

WARRANTY AND DISCLAIMER: The Company extends this limited warranty to the original purchaser and warrants that products supplied by the Company, shall be free from original defects in workmanship and materials for two years from date of shipment (except for the warranty periods noted for products listed below), provided same have been properly handled, stored, installed, serviced, maintained and operated. This warranty shall not apply to products which have been altered or repaired without the Company's express authorization, or altered or repaired in any way so as, in the Company's judgment, to affect its performance or reliability, nor which have been improperly installed or subjected to misuse, negligence, or accident, or incorrectly used in combination with other substances. The Purchaser assumes all risks and liability for results of use of all products.

Evaporative cooling pads are warranted to be free of defects in materials and workmanship for a period of two years from date of shipment provided same have been properly handled, stored, installed, serviced, maintained and operated; and further, not subjected to excessive heat, corrosive agents or chemicals, or mechanical abuse that may cause tearing, crushing or undue deterioration, nor used on a system or in a manner other than that for which it was designed as explained in the product literature.

The following products are warranted to be free of defects in materials and workmanship for the periods shown from date of shipment: Acme's exclusive duplex split pillow block bearings and shaft five years, belts one year, Polyethylene tubing 90 days, AIR40 Heater warranty one year, AIR40 Emitter warranty three years and DDP fan lifetime warranty on its propeller, cone, and housing.

LIMITATION OF REMEDY AND DAMAGES: All claims under this warranty must be made in writing and delivered to P. O. Box 978, Muskogee, Oklahoma, 74402, within 15 days after discovery of the defect and prior to the expiration of two years from the date of shipment by the Company of the product claimed defective, and Purchaser shall be barred from any

remedy if Purchaser fails to make such claim within such period.

Within 30 days after receipt of a timely claim, the Company shall have the option either to inspect the product while in Purchaser's possession or to request Purchaser to return the product to the Company at Purchaser's expense for inspection by the Company. The Company shall replace, or at its option repair, free of charge, any product it determines to be defective, and it shall ship the repaired or replacement product to Purchaser F.O.B. point of shipment; provided, however, if circumstances are such as in the Company's judgment to prohibit repair or replacement to remedy the warranted defects, the Purchaser's sole and exclusive remedy shall be a refund to the Purchaser of any part of the invoice price, paid to the Company, for the defective product or part.

The Company is not responsible for the cost of removal of the defective product or part, damages due to removal, or any expenses incurred in shipping the product or part to or from the Company's plant, or the installation of the repaired or replaced product or part.

The warranties set forth above do not apply to any components, accessories, parts or attachments manufactured by other manufacturers; such being subject to the manufacturer's warranty, if any. To the extent not prohibited by the manufacturer's warranty, the Company shall pass through to Purchaser such manufacturer's warranty.

THE COMPANY'S WARRANTY IS IN LIEU OF ALL OTHER WARRANTIES, EXPRESS OR IMPLIED, ARISING BY LAW OR OTHERWISE, INCLUDING WITHOUT LIMITATION THE IMPLIED WARRANTIES OF MERCHANTABILITY AND FITNESS FOR A PARTICULAR PURPOSE, WHICH ARE HEREBY EXPRESSLY DISCLAIMED AND WAIVED. THIS WARRANTY CONSTITUTES THE COMPANY'S SOLE AND EXCLUSIVE WARRANTY FOR DEFECTIVE GOODS AND PURCHASER'S SOLE AND EXCLUSIVE REMEDY FOR DEFECTIVE PRODUCTS.

No employee, agent, dealer, or other person is authorized to give any warranties on behalf of the Company or to assume for the Company any other liability in connection with any of its products except in writing and signed by an officer of the Company.

REPLACEMENT PARTS If replacement parts are ordered, purchaser warrants that the original components in which these replacement parts will be placed are in satisfactory working condition, and

when said replacement parts are installed, the resultant installation will operate in a safe manner, at speeds and temperatures for which the original product was purchased.

TECHNICAL ADVICE AND RECOMMENDATIONS, DISCLAIMER: Notwithstanding any past practice or dealings or any custom of the trade, sales shall not include the furnishing of technical advice or assistance or system design. Any such assistance shall be at the Company's sole option and may be subject to additional charge.

The Company assumes no obligation or liability on account of any recommendations, opinions or advice as to the choice, installation or use of products. Any such recommendations, opinions or advice are given and shall be accepted at Purchaser's and End User's risk and shall not constitute any warranty or guarantee of such products or their performance.

LIMITATION OF LIABILITY The cumulative liability of the Company to the Purchaser and any other persons for all claims in any way relating to or arising out of the products, including, but not limited to, any cause of action sounding in contract, tort, or strict liability, shall not exceed the total amount of the purchase price paid for those products which are the subject of any such claim. This limitation of liability is intended to apply without regard to whether other provisions of this agreement have been breached or have proven ineffective even if the Company has been advised of the possibility of such claims or demands. In no event shall the Company be liable to the Purchaser or any other person for any loss of profits or any incidental, special, exemplary, or consequential damages for any claims or demands brought by the Purchaser or such other persons.

INDEMNITY The Company's maximum liability to Purchaser and to any end user is as set forth above. The Company makes no warranty to anyone for any products not manufactured by the Company and shall have no liability for any use or installation of any products (whether manufactured by the Company or other manufacturers) not specifically authorized by this sale. Purchaser acknowledges various warnings by the Company regarding the products and its installation and use. If the Company incurs any claims, lawsuits, settlements, or expenses (including attorney fees) for any loss, injury, death or property damage including, but not limited to, claims arising out of the Purchaser's or any end user's installation or use of the products, the Purchaser shall indemnify and hold the Company harmless.



ACME ENGINEERING AND MANUFACTURING CORPORATION
P.O. Box 978
Muskogee, Oklahoma 74402
Telephone 918/682-7791
Fax 918/682-0134
www.acmefan.com